

SS SYSTEM CATALOG

Osstem Implant 2014-15 Comprehensive Catalog

Overall Planning/Editing PR Department Design Team

Supervision Implant Lab, Marketing PM

Production/Distribution Marketing & Planning Team

Date of Publication 2014.

Publisher Osstem Implant

8th FL, World Meridian II, 123, Gasan digital 2-ro,

Geumcheon-gu, Seoul, Korea

Phone +82.2.2016.7000

Fax +82.2.2016.7001

www.osstem.com

003 INTRODUCTION
012 CONTENTS
016 SS SYSTEM
064 REFERENCE

**"Osstem - Future
Technology and
Superior Quality"**

Products that dentists can trust.
That is the mission of
Osstem Implant.

**We deeply appreciate
all of our customers
who use our products.**

We deeply appreciate all of our customers who use our products. With population aging, rising incomes, and increased interest in health and aesthetics, implants have become an essential treatment in dentistry around the world. Today, implants are well-known as a safe and effective treatment option, and the leading treatment option for patients with no teeth. To satisfy this global trend, Osstem has invested heavily in R&D and continuously promotes innovative products, resulting in it becoming a global leader in technology and product quality. Osstem is releasing new products including TSIII CA, TSIII BA, SSIII HA, and MS SA, and is strengthening its product line-up in order to enable application in a variety of clinical cases. Other products to be released that will enable safe, easy implant procedures include SMARTbuilder, AutoBone collector, 123 KIT, and ESSET KIT.

TSIII CA in particular is expected to become a leading product in the global implant market after launching as a groundbreaking product with superior hydrophilic properties capable of at least 30% greater fusion than ordinary SA products due to its calcium ion solution encapsulation. Also, to improve our customers' convenience and foster reasonable purchasing, we have opened an online store, DenALL (www.denall.com), where dentistry materials can be purchased affordably and conveniently. Osstem leads the way in superior product quality and exports to over 50 countries including the USA, China, Japan, Germany, and India, and is the first company in Korea to record implant sales of over 30 million products and overseas subsidiary sales of over 100 billion won.

Osstem Implant CEO
Gyu-ok Choi (DDS, Ph.D)



Worldwide & History



1997

- 01 OSSTEM Co., Ltd. Founded
- 12 Launched "Doobunae" (health insurance claiming software)

2000

- 06 Launched "Hanaro" (dentistry management software)
- 10 Acquired Korean company Sumin Comprehensive Dental Materials

2001

- 01 Obtained CE-0434 certification
- 03 Established AIC Training Center

2002

- 01 Established Osstem Implant Research Center
- 08 Obtained US FDA certification
Launched USII implant
- 10 Launched SSII implant

2006

- 03 Changed company name to Osstem Implant Co., Ltd.
- 04 Obtained GOST-R certification in Russia
- 12 Established the first incorporation stage of overseas subsidiaries in 12 countries

2007

- 02 Listed on KOSDAQ stock exchange and began trading
- 06 Obtained GOST-R certification in Russia
- 12 Selected next-generation products
Obtained certification from Australia's Therapeutic Goods Administration

2008

- 01 Established Osstem's osteology research center
- 12 Selected as a National Strategic Leading Technology Company

2009

- 10 Obtained permission from Japan's Ministry of Health, Labor, and Welfare to produce and sell medical devices

2010

- 03 Launched TSIII SA implant
- 06 Launched TSIII HA implant
- 08 Selected as WPM Biomedical National Policy Company
- 12 Exceeded 10,000 dentistry software members

2011

- 06 Selected Osstem Implant Research Center as an ATC (Superior Technology Research Center)
- 07 Selected as a world champion business
- 10 Obtained Health Canada certification
- 12 Launched K2 unit chair
Selected as "Global First-Class Product"

2012

- 06 Launched TSIII CA implant
- 07 Established Osstem Medical Equipment Research Center

2013

- 01 Launched Osstem's xenograft "A-Oss"
- 09 Launched K3 unit chair
- 10 Selected as a hidden champion business

2014

- 05 Selected as a WorldClass 300 business

OSSTEM[®] Implant Design feature

Osstem Implant,

the leader in popularizing implants in Korea!
We stand out with our passion for strategic R&D and best products, creating globally trend-setting implants.

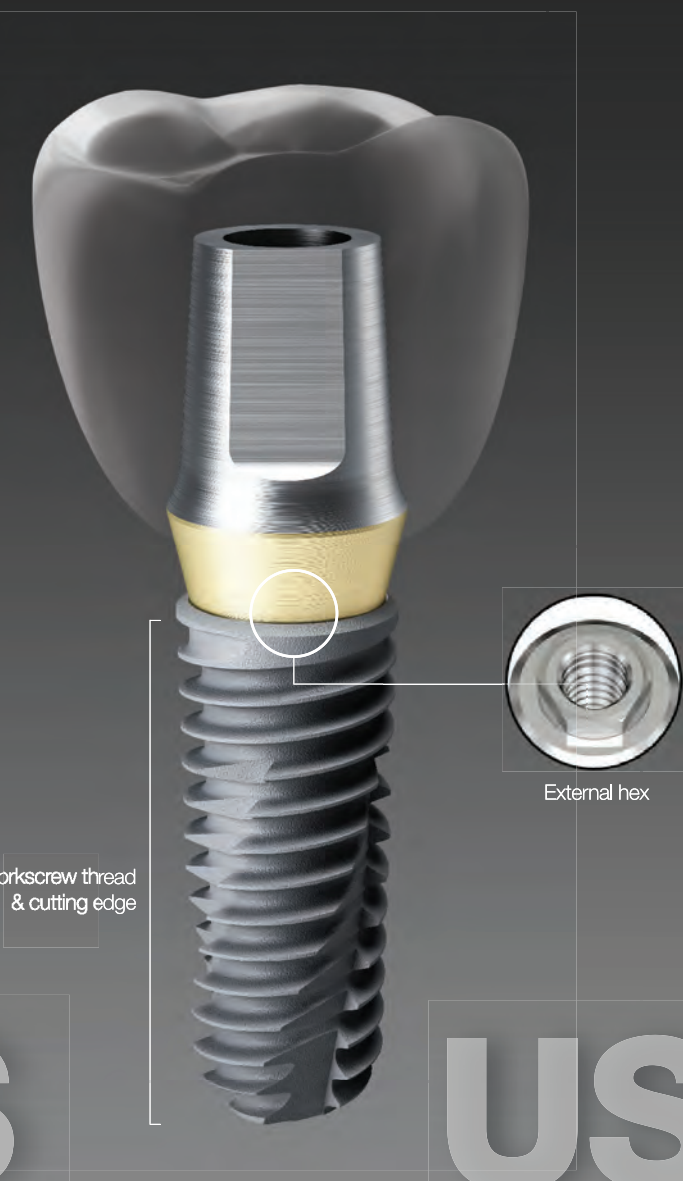
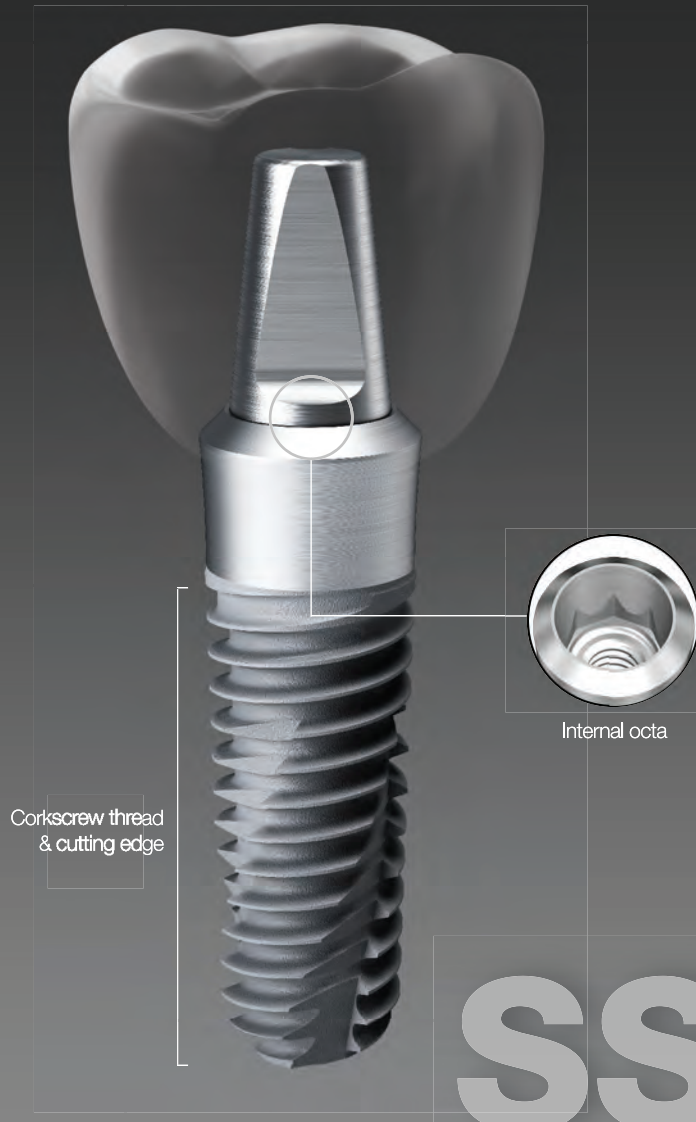
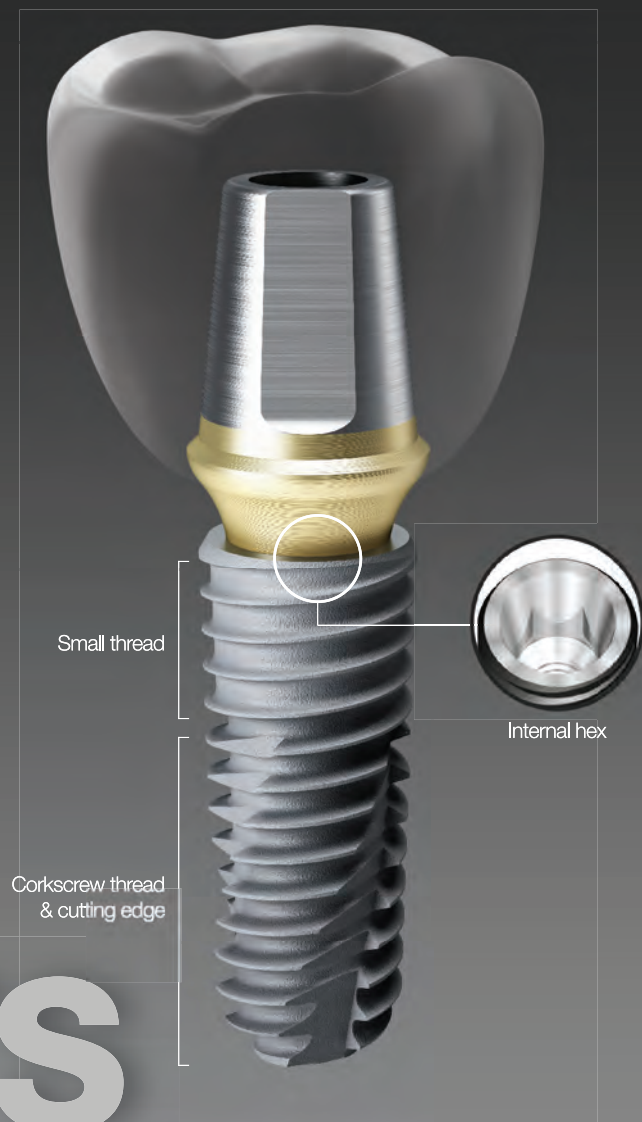

Packaging Color Information for Each System

• Submerged type implant with an Internal hex 11° taper connection structure

- Connection type and color - **Mini/Regular**
- Highest initial stability in soft bone by using upper-section small thread
- Corkscrew thread & cutting edge
 - Easy path adjustment through a superior self-threading effect
 - Acquires insertion torque with an increase in soft bone initial stability and without deviation according to the drill diameters
- The various body shape options are available according to the bone and patient's clinical condition
 - TSII (straight body): Easily adjustable insertion depth
 - TSIII (1.5° taper body): Able to acquire the initial stability needed for immediate loading even in soft bone
 - TSIV (6° taper body): Able to acquire superior initial stability only in maxillary sinus and soft bone

• Applied Surface - SA/CA/BA/HA

• Non-submerged type implant with an Internal octa 8° taper connection structure based on one-time procedures

- Connection type and color - **Regular/Wide**
- Corkscrew thread & cutting edge
 - Easy path adjustment through a superior self-threading effect
 - Acquires insertion torque with an increase in soft bone initial stability and without deviation according to the drill diameters
- The various body shape options are available according to the bone and patient's clinical condition
 - SSII (straight body): Easily adjustable insertion depth
 - SSIII (1.5° taper body): Able to acquire the initial stability needed for immediate loading even in soft bone

• Applied Surface - SA/CA/HA

• Submerged type implant with an external hex connection structure

- Connection type and color - **Mini/Regular/Wide Wide PS**
- Corkscrew thread & cutting edge
 - Easy path adjustment through a superior self-threading effect
 - Acquires insertion torque with an increase in soft bone initial stability and without deviation according to the drill diameters
- The various body shape options are available according to the bone and patient's clinical condition
 - USII (straight body): Easily adjustable insertion depth
 - USIII (1.5° taper body): Able to acquire the initial stability needed for immediate loading even in soft bone
 - USIV (6° taper body): Able to acquire superior initial stability only in maxillary sinus and soft bone

• Applied Surface - SA

OSSTEM[®] Implant Surface feature

Osstem Implant provides world-class surface technologies in surface treatment, the core implant technology for fast and safe procedures

SA

CA

BA

HA

• Provides optimum surface through acid treatment

- Provides Ra 2.5~3.0 μm surface roughness
However, upper section 0.5mm area is Ra 0.5~0.6 μm
- Achieved uniform micro-pit 1.3 μm in size
- 46% greater surface area compared to RBM

• Bone reaction performance (in-vitro and in-vivo)

- 20% improvement in osteoblast separation and ossification compared to RBM
- Initial bone reaction performance in animal model (mini-pig)
- 48% improvement in initial stability (RT, 4 weeks) compared to RBM
- 20% improvement in ossification (BIC, 4 weeks) compared to RBM

• Superhydrophilic SA surface encapsulated in calcium solution

- Maintains optimum surface identical to SA surface
- Surface activity maximized after encapsulated in calcium (CaCl_2) solution
- Increased ossification surface area through excellent blood wettability
- Improved bone reaction performance in the early osseointegration stage compared to SA surface

• Bone reaction performance (in-vitro and in-vivo)

- 3x increase in protein, cell adhesion compared to SA
- 19% increase in initial cell separation (7 days) compared to SA
- 34% improvement in initial stability (RT, 2 weeks) compared to SA
- 26% improvement in ossification (BIC, 2 weeks) compared to SA

• Surface coated with low crystalline Nano-HA in SA

- Ultra-thin film with HA coating and 10nm or lower thickness
- HA coating on SA surface (Ra 2.5~3.0 μm)
- Dual function of titanium and HA
- HA is naturally removed during ossification process

• Bone reaction performance (in-vitro and in-vivo)

- Fused surface having advantages of both SA and HA
- Maintains advantage of SA optimum surface formation
- Superior early ossification of the HA in soft bone condition
- 30% improvement in ossification (BIC) compared to SA

































































• Premium surface coated with high crystalline HA

- High crystalline HA coating 30~60 μm in thickness
- HA coating on RBM surface (Ra 3.0~3.5 μm)
- Achieved at least 98% HA high crystallization
- Solves problem of interbody fusion in low crystalline HA

• Bone reaction performance (in-vitro and in-vivo)

- Excellent biocompatibility in HA that is similar to bone
- 2x improvement in osteoblast ossification (5 days) compared to SA
- 40% improvement in initial stability (RT, 4 weeks) in animal models compared to SA
- Suitable for weak bone tissue, or tooth extraction or implant insertion

SS SYSTEM Contents

016 SSII SA Fixture 	018 SSIII SA Fixture 	020 SSIII CA Fixture 	022 SSIII HA Fixture 	024 Simple Mount 	045 SmartFit Abutment 	046 ComOcta Angled Abutment 	047 ComOcta Retraction Cap 	047 Fixture Pick-up Impression Coping 	048 Fixture Transfer Impression Coping 
024 Cover Screw 	025 Headless Cover Screw 	025 Closing Screw 	026 Healing Abutment 	029 Solid Abutment 	048 Fixture Lab Analog 	049 Hanaro Abutment 	051 Octa Abutment 	052 Octa Protect Cap 	052 Octa Gold Cylinder 
030 Solid Protect Cap 	030 Solid Retraction Cap 	030 Solid Positioning Cylinder 	031 Solid Impression Coping 	031 Solid Lab Analog 	052 Octa Combination Cylinder 	053 Octa Temporary Cylinder 	053 Octa Plastic Cylinder 	054 Octa Pick-up Impression Coping 	054 Octa Transfer Impression Coping 
031 Solid Burn-out Cylinder 	032 Solid Impression Cap 	032 Solid Shoulder Analog 	032 Solid Shoulder Analog Pin 	033 Excellent Solid Abutment 	054 Octa Lab Analog 	057 O-ring Abutment 	058 O-ring Retainer Cap Set 	058 O-ring Retainer Set 	058 O-ring Set 
034 Excellent Solid Protect Cap 	034 Excellent Solid Retraction Cap 	034 Excellent Solid Positioning Cylinder 	035 Excellent Solid Impression Coping 	035 Excellent Solid Lab Analog 	058 O-ring Lab Analog 	059 Locator® Abutment 	060 Locator® Male Processing Kit 	060 Locator® Replacement Male 	060 Locator® Extended Replacement Male 
035 Excellent Solid Burn-out Cylinder 	036 Excellent Solid Impression Cap 	036 Excellent Solid Shoulder Analog 	036 Excellent Solid Shoulder Analog Pin 	039 ComOcta Abutment 	061 Locator® Black Processing Male 	061 Locator® Block Out Spacers 	061 Locator® Impression Coping 	061 Locator® Lab Analog 	062 Locator® Core Tool 
040 ComOcta Plus Abutment 	041 ComOcta Milling Abutment 	042 ComOcta Gold Abutment 	043 ComOcta NP-Cast Abutment 	044 ComOcta Temporary Abutment 	062 Locator® Torque Driver 				

OSSTEM[®]
IMPLANT

SS SYSTEM

FIXTURE

- 016** SSII SA Fixture
- 018** SSIII SA Fixture
- 020** SSIII CA Fixture
- 022** SSIII HA Fixture
- 024** Simple Mount
- 025** Cover Screw
- 025** Headless Cover Screw
- 025** Closing Screw
- 026** Healing Abutment

COMPONENTS

- 028** PROSTHETIC FLOW DIAGRAM 1
- 030** Solid Abutment
- 033** Excellent Solid Abutment
- 038** PROSTHETIC FLOW DIAGRAM 2
- 039** ComOcta Abutment
- 040** ComOcta Plus Abutment
- 041** ComOcta Milling Abutment
- 042** ComOcta Gold Abutment
- 043** ComOcta NP-Cast Abutment
- 044** ComOcta Temporary Abutment
- 045** SmartFit Abutment
- 046** ComOcta Angled Abutment
- 049** Hanaro Abutment
- 050** PROSTHETIC FLOW DIAGRAM 3
- 051** Octa Abutment
- 056** PROSTHETIC FLOW DIAGRAM 4
- 057** O-ring Abutment
- 059** Locator[®] Abutment

SSII SA Fixture

- Non-submerged implants based on one-stage surgery with internal octa and 8° taper connections
- Optimum screw thread design for optimum SA surface
- Straight body design for easy adjustment of insertion depth
- Powerful self-threading effect using corkscrew thread
- Recommended insertion torque : 40Ncm or lower
- ※ In single implant cases for posterior region, use of fixture at least 4.5mm in diameter is recommended

NoMount fixture order code

: fixture product code (ex : SS2R4011S18)

Pre-Mounted fixture order code (fixture + simple mount + cover screw)

: A + fixture product code (ex : ASS2R4011S18)

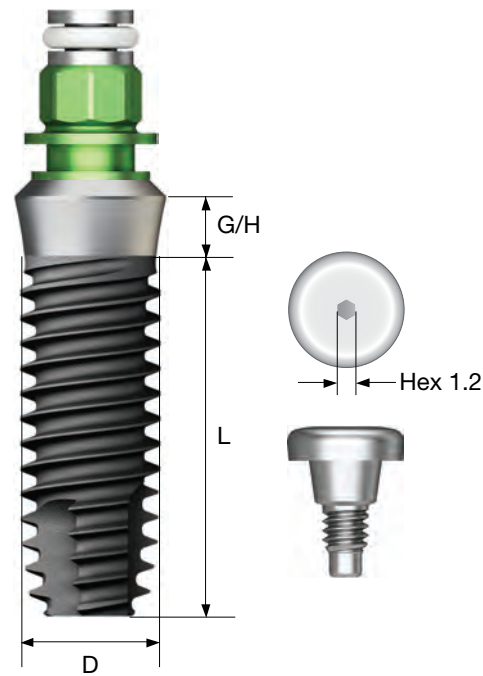

D Ø5.0
P Ø6.0
W

G/H \ L	6	7	8.5	10	11.5	13
Short						
2.0	SS2W5006S20	SS2W5007S20	SS2W5008S20	SS2W5010S20	SS2W5011S20	SS2W5013S20

016

D Ø4.0
P Ø4.8

R

G/H \ L	7	8.5	10	11.5	13
1.8	SS2R4007S18	SS2R4008S18	SS2R4010S18	SS2R4011S18	SS2R4013S18
2.8		SS2R4008S28	SS2R4010S28	SS2R4011S28	SS2R4013S28

D Ø4.5
P Ø4.8

R

G/H \ L	7	8.5	10	11.5	13
1.8	SS2R4507S18	SS2R4508S18	SS2R4510S18	SS2R4511S18	SS2R4513S18
2.8		SS2R4508S28	SS2R4510S28	SS2R4511S28	SS2R4513S28

D Ø4.5
P Ø6.0

W

G/H \ L	7	8.5	10	11.5	13
2.0	SS2W4507S20	SS2W4508S20	SS2W4510S20	SS2W4511S20	SS2W4513S20

017

SS SYSTEM

SSIII SA Fixture

- Non-submerged implants based on one-stage surgery with internal octa and 8° taper connections
- Optimum screw thread design for optimum SA surface
- Taper body design with superior initial stability
- Powerful self-threading effect using corkscrew thread
- Acquires the initial stability needed in immediate loading even in soft bone

Ultra-wide

- Immediate placement in tooth extraction case and useful in exchanging a failed implant
 - With its optimized apex design, capable to obtain stable initial stability in the cases of tooth extraction and at the bottom 3mm
 - Recommended insertion torque : 40Ncm or lower
- ※ In single implant cases for posterior region, use of fixture at least 4.5mm in diameter is recommended

NoMount fixture order code

: fixture product code (ex : SS3R4011S18)

Pre-Mounted fixture order code (fixture + simple mount + cover screw)

: **A** + fixture product code (ex : ASS3R4011S18)

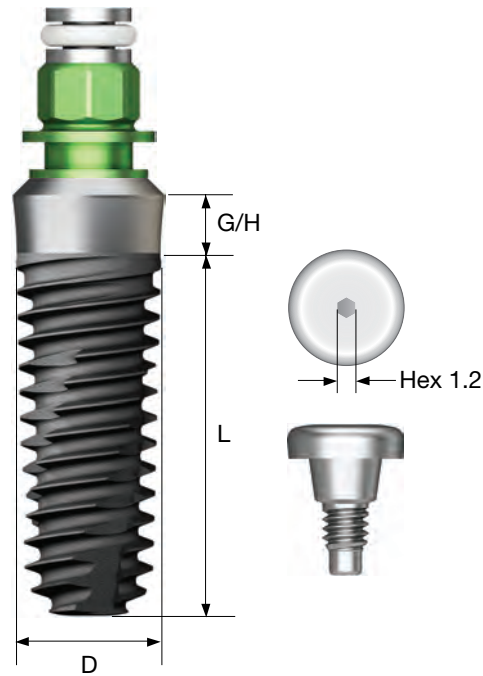

D Ø4.5
P Ø6.0
W

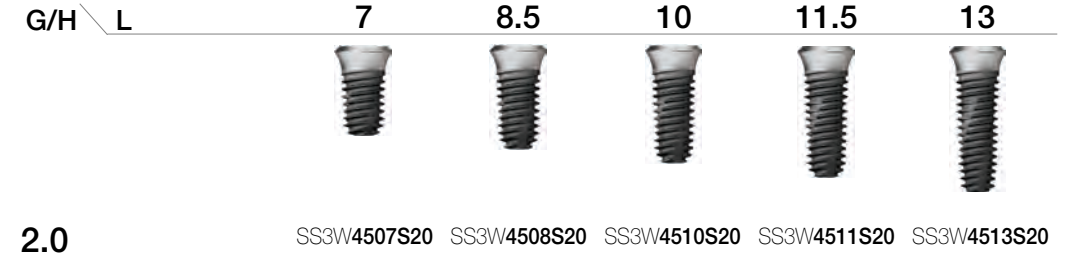

D Ø5.0
P Ø6.0
W

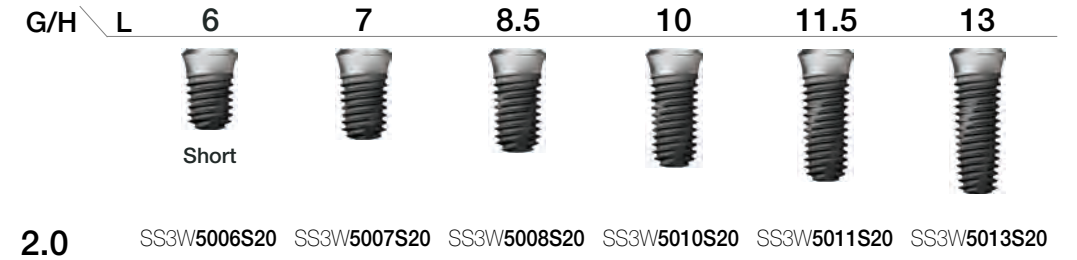

Ultra-wide

D Ø6.0
P Ø6.0
W

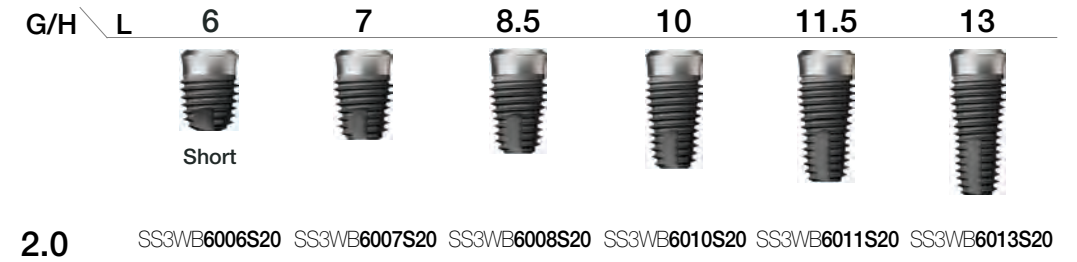

D Ø7.0
P Ø6.0
W

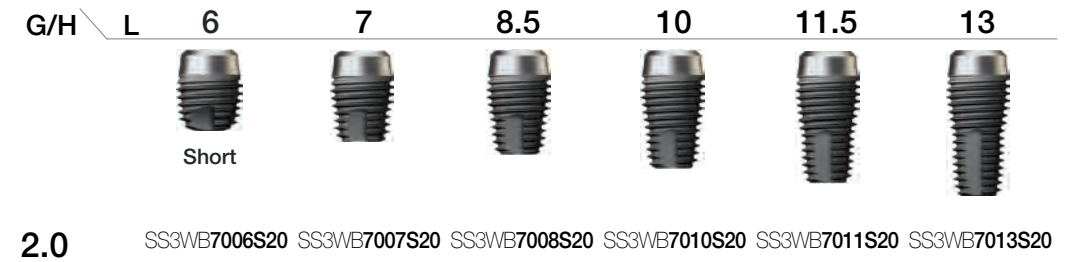

D Ø3.5
P Ø4.8
R

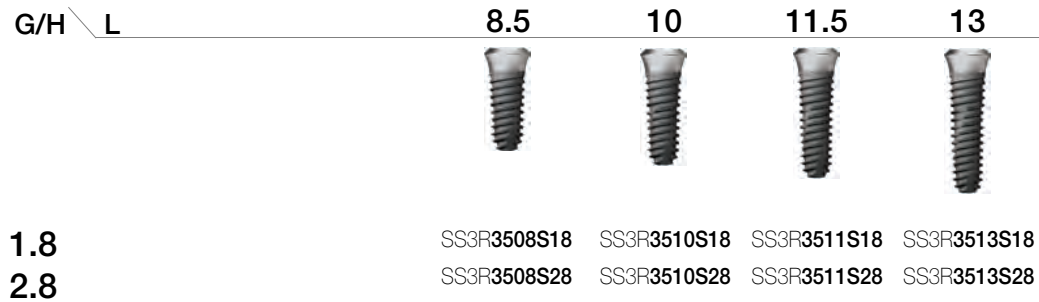

D Ø4.0
P Ø4.8
R

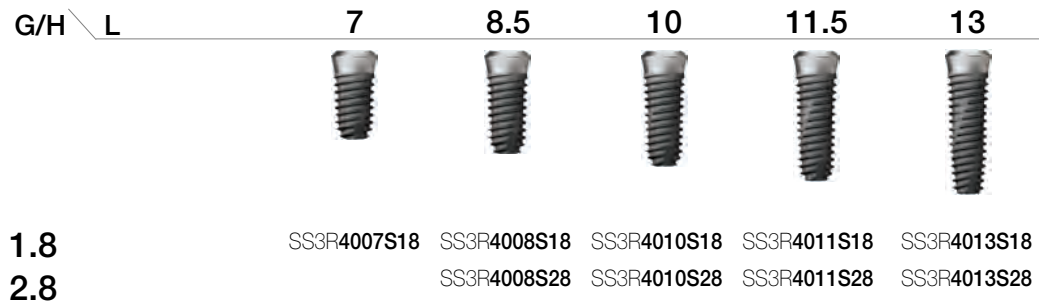

D Ø4.5
P Ø4.8
R

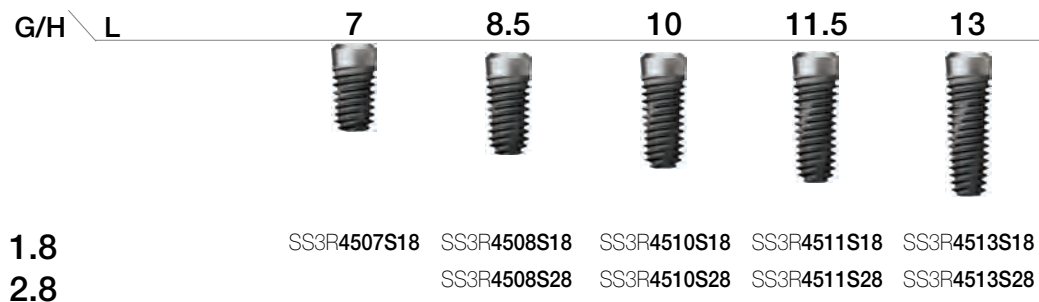

SSIII CA Fixture

- Non-submerged implants based on one-stage surgery with internal octa and 8° taper connections
- Superior hydrophilic SA surface encapsulated in calcium solution
- Taper body design with superior initial stability
- Powerful self-threading effect using corkscrew thread
- Acquires the initial stability needed in immediate loading even in soft bone

Ultra-wide

- Immediate placement in tooth extraction case and useful in exchanging a failed implant
- With its optimized apex design, capable to obtain stable initial stability in the cases of tooth extraction and at the bottom 3mm
- Recommended insertion torque: 40Ncm or lower
- ※ In single implant cases for posterior region, use of fixture at least 4.5mm in diameter is recommended

NoMoun fixture order code

: fixture product code (ex : SS3R4011C18)

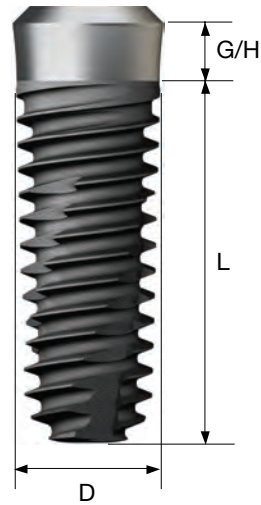

D Ø4.5
P Ø6.0

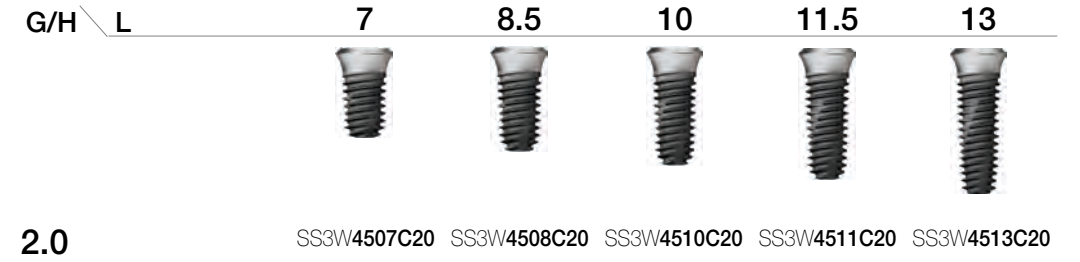

D Ø5.0
P Ø6.0

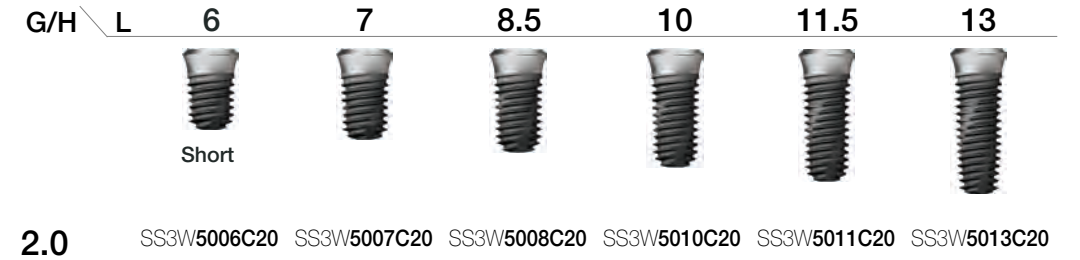

Ultra-wide

D Ø6.0
P Ø6.0

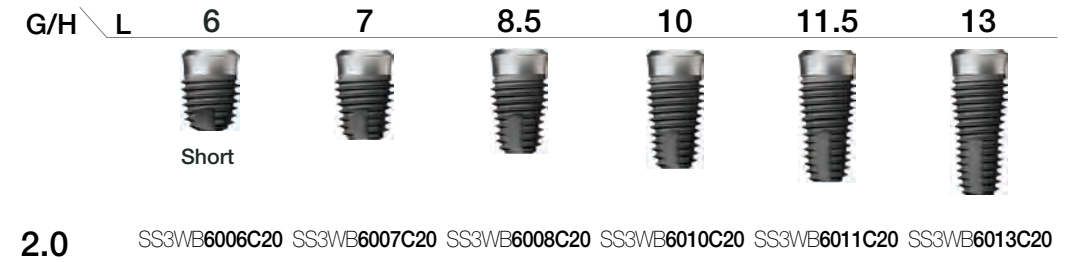

D Ø7.0
P Ø6.0

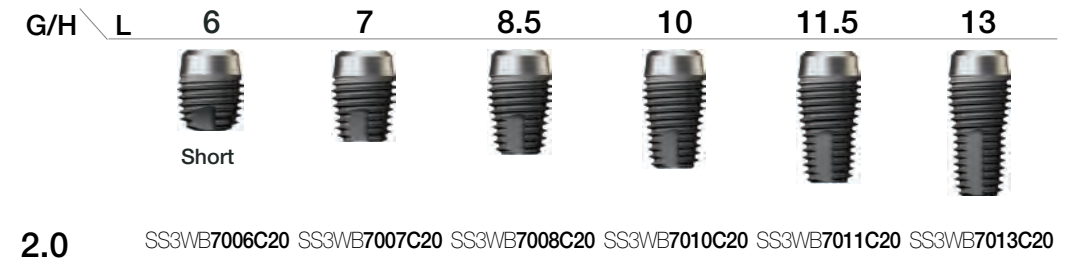

D Ø3.5
P Ø4.8

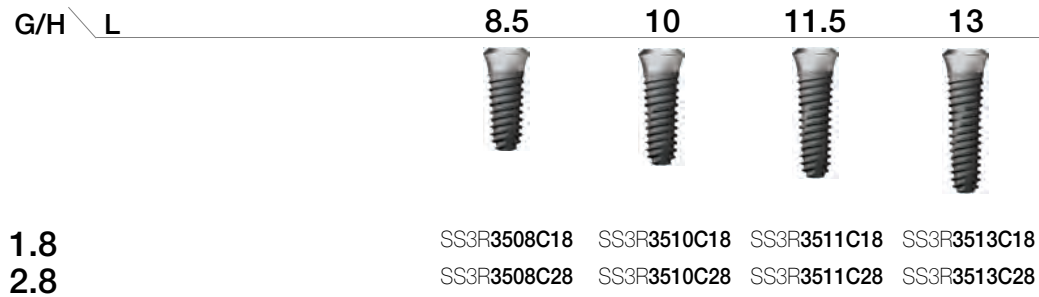

D Ø4.0
P Ø4.8

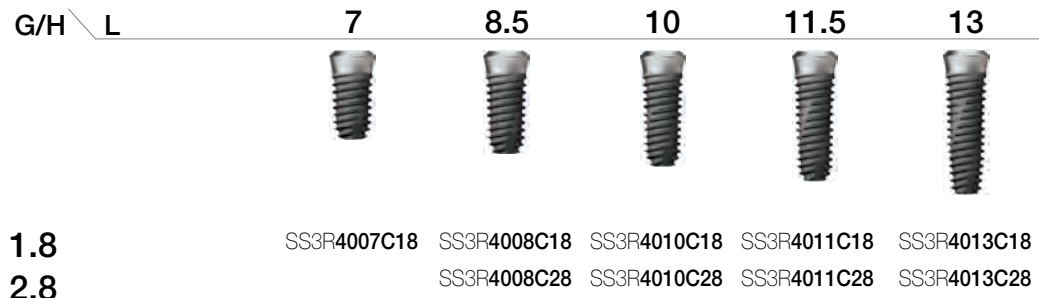

D Ø4.5
P Ø4.8

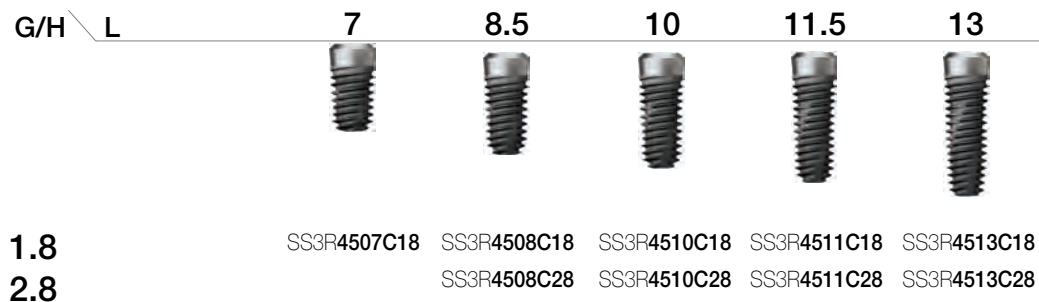

SSIII HA Fixture

- Non-submerged implants based on one-stage surgery with internal octa and 8° taper connections
- Premium surface coated with high crystalline HA
- Taper body design with superior initial stability
- Powerful self-threading effect using corkscrew thread
- Acquires the initial stability needed in immediate loading even in soft bone
- Recommended insertion torque: 35Ncm or lower
- ※ In single implant cases for posterior region, use of fixture at least 4.5mm in diameter is recommended
- ※ HA fixture is not recommended in hard bone due to possibility of coating layer cracks and desquamation

Pre-Mounted fixture order code (fixture + simple mount + cover screw)

: **A** + fixture product code (ex : ASS3R4011H18)

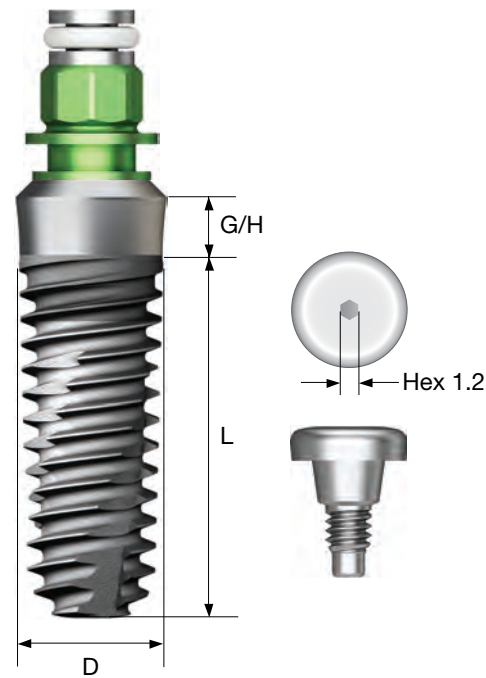

D Ø5.0
P Ø6.0
W

G/H \ L	6	7	8.5	10	11.5	13
Short						
2.0	SS3W5006H20	SS3W5007H20	SS3W5008H20	SS3W5010H20	SS3W5011H20	SS2W5013H20

022

D Ø4.0
P Ø4.8
R

G/H \ L	7	8.5	10	11.5	13
1.8	SS3R4007H18	SS3R4008H18	SS3R4010H18	SS3R4011H18	SS3R4013H18
2.8		SS3R4008H28	SS3R4010H28	SS3R4011H28	SS3R4013H28

D Ø4.5
P Ø4.8
R

G/H \ L	7	8.5	10	11.5	13
1.8	SS3R4507H18	SS3R4508H18	SS3R4510H18	SS3R4511H18	SS3R4513H18
2.8		SS3R4508H28	SS3R4510H28	SS3R4511H28	SS3R4513H28

D Ø4.5
P Ø6.0
W

G/H \ L	7	8.5	10	11.5	13
2.0	SS3W4507H20	SS3W4508H20	SS3W4510H20	SS3W4511H20	SS3W4513H20

023

SS SYSTEM

Mount & Screw

Simple Mount

- Hex driver : 1.2
- Recommended tightening torque : 8~10Ncm
- Packing unit : mount + mount screw
- C = Connection

R Regular

W Wide

C

R



SSH**RG**

W



SSH**WB**

Headless Cover Screw

- Used when adjacent space is limited or there is insufficient gum tissue in the suture area
- Hex driver : 0.9(mini)
- Recommended tightening torque : 5~8Ncm
- C = Connection

M Mini

R Regular

W Wide

C

M



HCM**100**

Cover Screw

- Hex driver : 0.9(mini), 1.2(regular/wide)
- Recommended tightening torque : 5~8Ncm
- C = Connection

M Mini

R Regular

W Wide

C

M



SGCM**100**

R



SSCS**480**

W



SSCS**600**

Closing Screw

- Used when adjacent space is limited or there is insufficient gum tissue in the suture area
- Hex driver : 1.2
- Recommended tightening torque : 5~8Ncm
- C = Connection

R Regular

W Wide

C

R



SSCS**480N**

W



SSCS**600N**

Healing Abutment

- Hex driver : 1.2
- Recommended tightening torque : 5~8Ncm

- R** Regular
- W** Wide



OSSTEM[®]
IMPLANT

026

D \ H	2.0	3.0	4.0	5.0
Ø 4.8	 SSH482	 SSH483	 SSH484	 SSH485

027

SS SYSTEM

D \ H	2.0	3.0	4.0	5.0
Ø 6.0	-	 SSH603	 SSH604	 SSH605

Solid / Excellent Solid

Abutment Level Impression

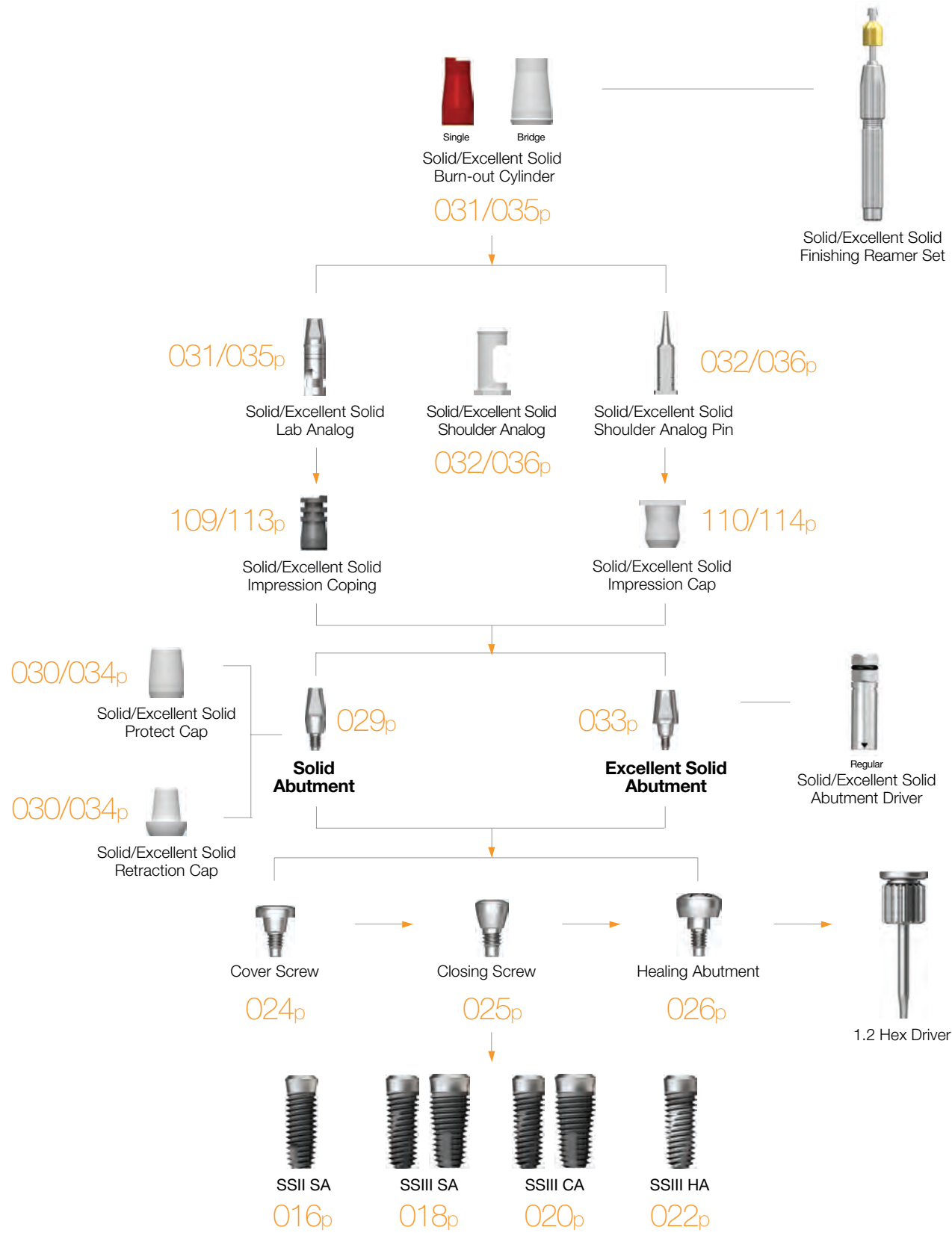

Solid Abutment

- Used in producing ordinary cement type prosthetics
- $\varnothing 4.8$: solid abutment driver (243p)
- $\varnothing 6.0$: 1.2 hex driver
- Recommended tightening torque : 30Ncm
- Packing unit : abutment + protect cap

Abutment + protect cap order code
: product code + P (ex : SSS485P)

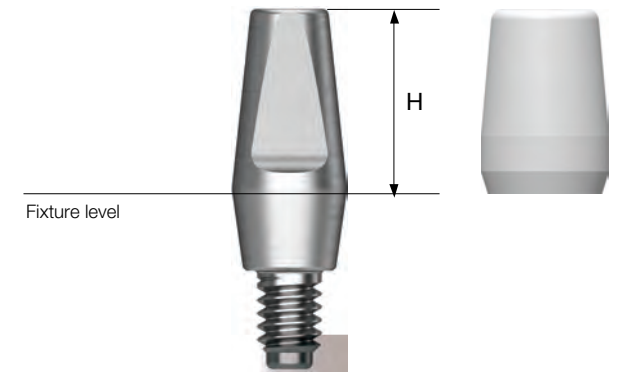

D $\varnothing 4.8$

R



D $\varnothing 6.0$

W









Solid Abutment Components

Solid Protect Cap

- Used when protecting a solid abutment in the oral cavity and minimizing foreign body sensation in the patient
- Able to be applied in lower structure of a temporary prosthetic





R Regular
W Wide

D \ H	4.0	5.5	7.0
Ø 4.8	 SSC484	 SSC485	 SSC487
Ø 6.0	 SSC604	 SSC605	 SSC607

Solid Impression Coping

- Used in taking impressions
- Unification of existing positioning cylinder and impression cap



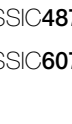



R Regular
W Wide

D \ H	4.0	5.5	7.0
Ø 4.8	 SSIC484	 SSIC485	 SSIC487
Ø 6.0	 SSIC604	 SSIC605	 SSIC607

Solid Retraction Cap

- Accurate margin impression function when taking impression directly from a solid abutment







R Regular
W Wide

D \ H	4.0	5.5	7.0
Ø 4.8	 SSSRC484	 SSSRC485	 SSSRC487
Ø 6.0	 SSSRC604	 SSSRC605	 SSSRC607

Solid Lab Analog

- Achieves solid abutment of the oral cavity on a working model
- Achieves small groove for G/H identification





R Regular
W Wide

D \ H	4.0	5.5	7.0
Ø 4.8	 SSSA484	 SSSA485	 SSSA487
Ø 6.0	 SSSA604	 SSSA605	 SSSA607

Solid Positioning Cylinder

- Used in taking impressions when solid impression cap is attached

R Regular
W Wide

D \ H	4.0	5.5	7.0
Ø 4.8	 SSPG484	 SSPG485	 SSPG487
Ø 6.0	 SSPG604	 SSPG605	-

Solid Burn-out Cylinder

- Used as a prosthetic framework when solid lab analog is attached
- After casting a prosthetic, margin area is adjusted using specialized reamer

R Regular
W Wide

D \ H	Single	Bridge
Ø 4.8	 SSSP480S	 SSSP480B
Ø 6.0	 SSSP600S	 SSSP600B

Solid Abutment Components

Solid Impression Cap

- Component for impression used when removing solid abutment
- Used when solid shoulder analog is attached

R Regular

W Wide

Ø 4.8
Ø 6.0



SSIP480
SSIP600

D \

Excellent Solid Abutment

- Advantageous when altering abutments to be larger than solid abutments
- Ø 4.8 : excellent solid abutment driver or 1.2 hex driver
- Ø 6.0 : 1.2 hex driver
- Recommended tightening torque : 30Ncm
- Packing unit : abutment + protect cap

Abutment + protect cap order code
: product code + **P** (ex : SSE485P)

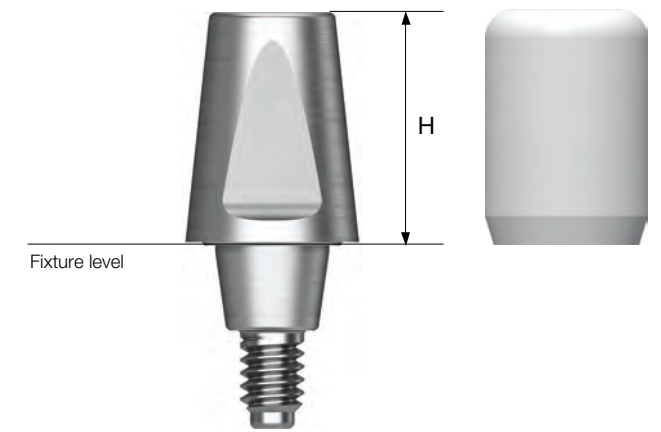

Solid Shoulder Analog

- Component for impression used when removing solid abutment
- Achieves fixture platform in working model
- Used with excellent solid shoulder analogs

R Regular

W Wide

Ø 4.8
Ø 6.0



SSSLA480
SSSLA600

D \

D Ø 4.8

R

H 4.0 5.5 7.0



SSE484



SSE485



SSE487

Solid Shoulder Analog Pin

- Component for impression used when removing solid abutment
- Used when solid shoulder analog is attached
- Prosthetic component for preventing fractures in working models
- Used with excellent solid shoulder analog pins

R Regular

W Wide

Ø 4.8
Ø 6.0



SSSAP480

D \

D Ø 6.0

W

H 4.0 5.5 7.0



SSE604



SSE605









SSE607

Excellent Solid Abutment Components

Excellent Solid Protect Cap

- Used when protecting an excellent solid abutment in the oral cavity and minimizing foreign body sensation in the patient
- Able to be applied in lower structure of a temporary prosthetic







R Regular
W Wide

D \ H	4.0	5.5	7.0
Ø 4.8	 SSEC484	 SSEC485	 SSEC487
Ø 6.0	 SSEC604	 SSEC605	 SSEC607

Excellent Solid Impression Coping

- Used in taking impressions
- Unification of existing positioning cylinder and impression cap







R Regular
W Wide

D \ H	4.0	5.5	7.0
Ø 4.8	 SSEIC484	 SSEIC485	 SSEIC487
Ø 6.0	 SSEIC604	 SSEIC605	 SSEIC607

Excellent Solid Retraction Cap

- Able to take an impression with an accurate margin when taking a direct impression from an excellent solid abutment



R Regular
W Wide

D \ H	4.0	5.5	7.0
Ø 4.8	 SSERC484	 SSERC485	 SSERC487
Ø 6.0	 SSERC604	 SSERC605	 SSERC607

Excellent Solid Lab Analog

- Achieves an excellent solid abutment of the oral cavity on a working model
- Achieves small groove for G/H identification



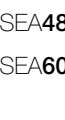
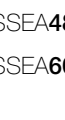
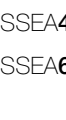

R Regular
W Wide

D \ H	4.0	5.5	7.0
Ø 4.8	 SSEA484	 SSEA485	 SSEA487
Ø 6.0	 SSEA604	 SSEA605	 SSEA607

Excellent Solid Positioning Cylinder

- Used when taking an impression while excellent solid impression cap is attached

R Regular
W Wide

D \ H	4.0	5.5	7.0
Ø 4.8	 SSEPG484	 SSEPG485	 SSEPG487
Ø 6.0	 SSEPG604	 SSEPG605	-

Excellent Solid Burn-out Cylinder

- Used as a prosthetic framework when excellent solid lab analog is attached
- After casting a prosthetic, margin area is adjusted using specialized reamer

R Regular
W Wide

D \ H	Single	Bridge
Ø 4.8	 SSEP480S	 SSEP480B
Ø 6.0	 SSEP600S	 SSEP600B

Excellent Solid Abutment Components

Excellent Solid Impression Cap

- Component for impression to be used when removing an excellent solid abutment
- Attach excellent solid shoulder analog and use

R Regular

W Wide



Excellent Solid Shoulder Analog

- Component for impression to be used when removing an excellent solid abutment
- Achieves fixture platform in working model
- Used with solid shoulder analog

R Regular

W Wide



Excellent Solid Shoulder Analog Pin

- Component for impression to be used when removing an excellent solid abutment
- Attach excellent solid shoulder analog and use
- Prosthetic component for preventing fractures in working models
- Used with solid shoulder analog pin

R Regular

W Wide

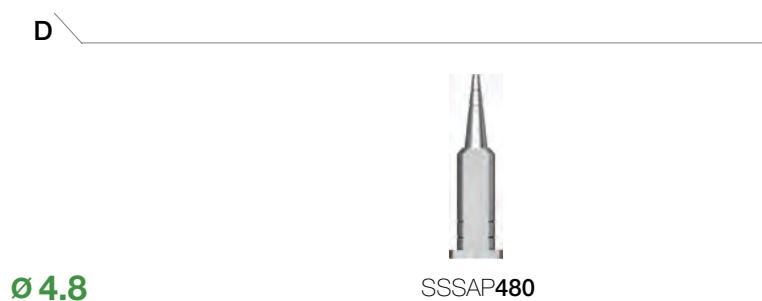

OSSTEM[®]
IMPLANT

ComOcta / SmartFit

Fixture Level Impression

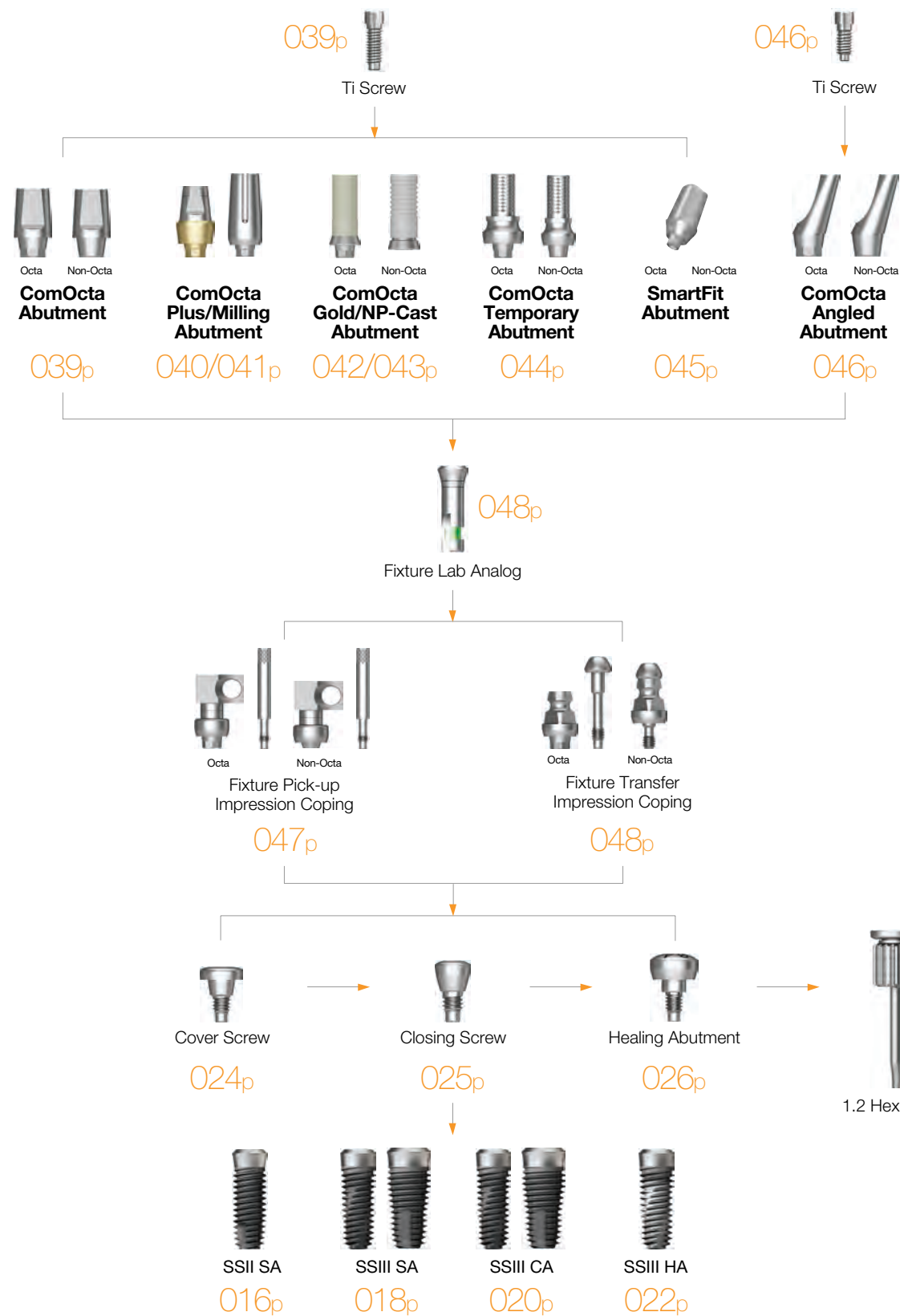

ComOcta Abutment

- Used in producing ordinary cement type prosthetics
- 1.2 hex driver
- Recommended tightening torque : 30 Ncm
- Packing unit : abutment + Ti screw

Abutment + Ti screw order code
: product code + TH (ex : SSCA485TH)

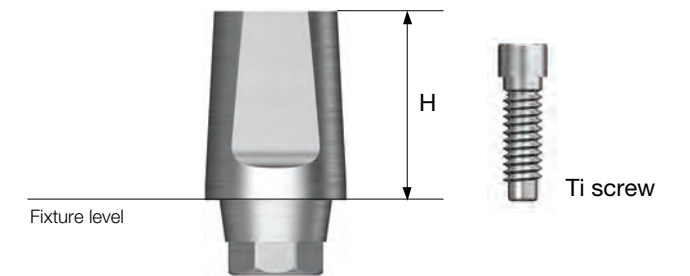

D Ø4.8 R Ti screw : ASR200	H 4.0			H 5.5		H 7.0	
	Type	Octa	Non-Octa	Octa	Non-Octa	Octa	Non-Octa
	SSCA484	SSCA485	SSCA487	SSCA484N	SSCA485N	SSCA487N	SSCA487N

D Ø6.0 W Ti screw : ASR200	H 4.0			H 5.5		H 7.0	
	Type	Octa	Non-Octa	Octa	Non-Octa	Octa	Non-Octa
	SSCA604	SSCA605	SSCA607	SSCA604N	SSCA605N	SSCA607N	SSCA607N

ComOcta Plus Abutment

- Used when there is deep gingiva or a fixture is to be deeply inserted
- Gold coloring on gingiva region for aesthetics
- Shoulder contact with fixture platform region
- 1.2 hex driver
- Recommended tightening torque : 30 Ncm
- Packing unit : abutment + Ti screw

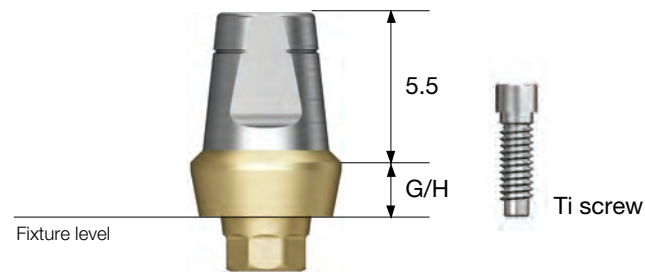

Abutment + Ti screw order code
: product code + **TH** (ex : SSCAP4826**CTH**)

ComOcta Milling Abutment

- Tightening torque : 30 Ncm
- Uses 1.2 hex driver
- Used when an abutment's path must be altered or a prosthetic's margin area must be customized
- Shoulder contact with fixture platform region
- Packing unit : abutment + Ti Screw

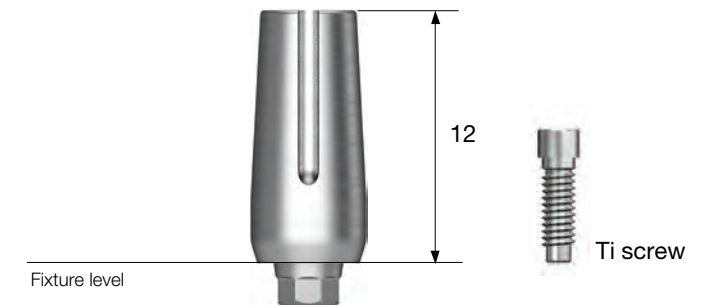

Abutment + Ti screw order code
: product code + **TH** (ex : SSCMA4830**TH**)

040

D Ø4.8



Ti screw : ASR200

	G/H	1.0	2.0	3.0	4.0
Octa					
Non-Octa					

SS SYSTEM

D Ø4.8



Ti screw : ASR200

G/



SSCMA4830

D Ø6.0



Ti screw : ASR200

2.0



SSCMA6030

041

SS SYSTEM

D Ø6.0



Ti screw : ASR200

	G/H	1.0	2.0	3.0	4.0
Octa					
Non-Octa					

ComOcta Gold Abutment

- Used when path, aesthetics, or space have limitations
- Shoulder contact with fixture platform region
- Prosthetic must be produced by casting dental-grade gold alloy
- Abutment region fusion range : 1400°C~1450°C
(casting with non-precious metal alloys is incompatible)
- 1.2 hex driver
- Recommended tightening torque : 30 Ncm
- Packing unit : abutment + Ti screw

Abutment + Ti screw order code
: product code + **TH** (ex : COG480STH)

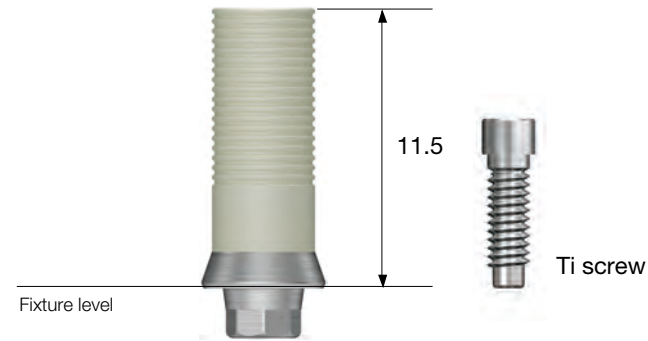

ComOcta NP-Cast Abutment

- Used when path, aesthetics, or space have limitations
- Shoulder contact with fixture platform region
- Prosthetic must be produced by casting dental-grade non-precious metal alloy
- Abutment region fusion range : 1400°C~1550°C
- 1.2 hex driver
- Recommended tightening torque : 30 Ncm
- Packing unit : abutment + Ti screw

Abutment + Ti screw order code
: product code + **TH** (ex : CON480STH)

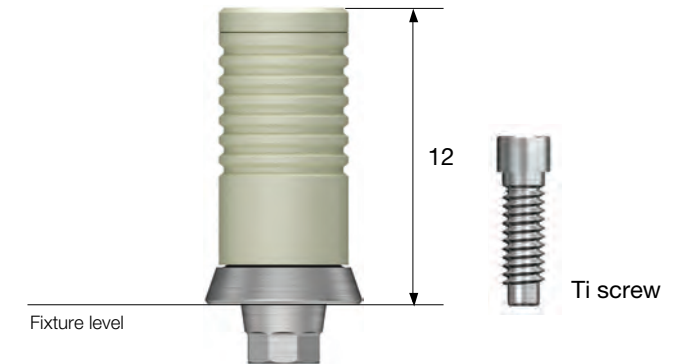

042

D Ø4.8 \ Type **Octa** **Non-Octa**

R
Ti screw : ASR200

COG480S COG480B

D Ø6.0 \ Type **Octa** **Non-Octa**

W
Ti screw : ASR200

COG600S COG600B

043

D Ø4.8 \ Type **Octa** **Non-Octa**

R
Ti screw : ASR200

CON480S CON480B

D Ø6.0 \ Type **Octa** **Non-Octa**

W
Ti screw : ASR200

CON600S CON600B

ComOcta Temporary Abutment

- Used in producing temporary prosthetics (Material: Ti Gr-3)
- Structure enabling easy customization and minimizing indication restrictions
- 1.2 hex driver
- Recommended tightening torque : 20Ncm
- Packing unit : abutment + Ti screw

Abutment + Ti screw order code
: product code + **TH** (ex : SSTA0480**TH**)

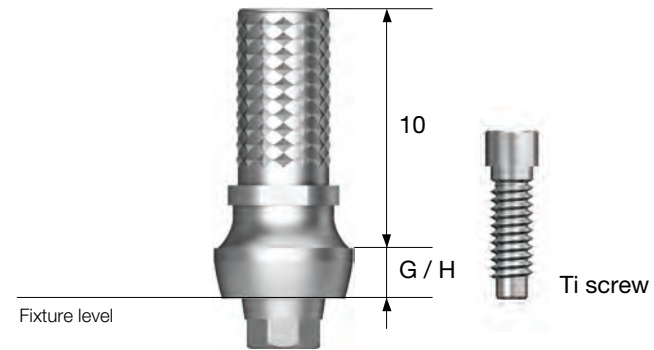

SmartFit Abutment

- CAD/CAM abutment
- 1.2 hex driver
- Recommended tightening torque : 20Ncm(mini), 30Ncm(regular)

- Recommended clinical case
 - Case where implant insertion area or angle is incorrect (max 30°)
 - Multiple cases requiring consistent path and stable support
 - Anterior case where aesthetic design is required
 - Irregular or exceedingly deep gingiva case

- How to Order**
- Fill out order sheet
 - Send necessary items for each case to Osstem Implant CAD/CAM center
 - Working time : 5~7days

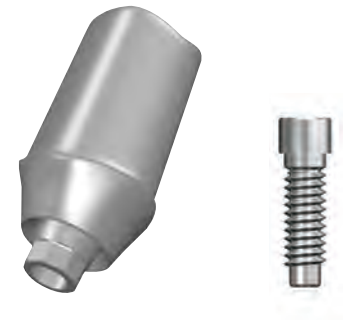

D Ø4.8



Ti screw : ASR200

G/H Type	0	2.0	0	2.0
	Octa		Non-Octa	
	SSTA0480	SSTA0482	SSTAN480	SSTAN482

D Ø6.0



Ti screw : ASR200

G/H Type	0	2.0	0	2.0
	Octa		Non-Octa	
	SSTA0600	SSTA0602	SSTAN600	SSTAN602

ComOcta Angled Abutment

- Used when adjusting path of prosthetic is necessary
- Stable connection with 8° morse taper structure
- 1.2 hex driver
- Recommended tightening torque : 30 Ncm
- Packing unit : abutment + Ti screw

Abutment + Ti screw order code
: product code + **TH** (ex : SSA4815**TH**)

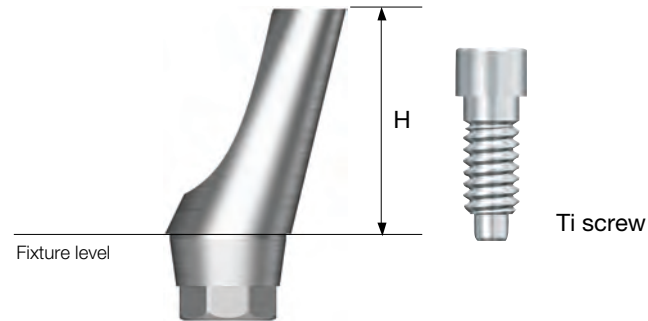

D Ø4.8



Ti screw : ASS200

Angle Type	15°	20°	15°	20°
	Octa		Non-Octa	
	SSA4815	SSA4820	SSA4815N	SSA4820N

D Ø6.0



Ti screw : ASS200

Angle Type	15°	20°	15°	20°
	Octa		Non-Octa	
	SSA6015	SSA6020	SSA6015N	SSA6020N

ComOcta Abutment Components

ComOcta Retraction Cap

- Able to take an accurate margin impression when taking an impression directly from a ComOcta abutment

R Regular

W Wide

D \ H	4.0	5.5	7.0
Ø 4.8	 SSCRC484	 SSCRC485	 SSCRC487
Ø 6.0	 SSCRC604	 SSCRC605	 SSCRC607

Fixture Pick-up Impression Coping

- Takes impression using open tray
- Superior impression stability with holinone structure
- 1.2 hex driver
- * Label is basic packaging specification
- Packing unit : impression coping body + guide pin

R Regular

W Wide

D \ L	5		10		Guide Pin		
	Octa	Non-Octa	Octa	Non-Octa	10	15	17
Ø 4.8							
Ø 6.0	SSICAS480	SSICAS480N	SSICA480	SSICA480N			
	SSICAS600	SSICAS600N	SSICA600	SSICA600N			

ComOcta Abutment Components

Fixture Transfer Impression Coping

- Takes impression using closed tray
- Increased popularity after creating impression with gemstone-shaped structure ()
- 1.2 hex driver
- Packing unit : octa - Impression coping + guide pin
non-octa - Impression coping

-  Regular
-  Wide

D \ L	Type			
	9.5		12.5	
	Octa		Non-Octa	
				
	SSCTIS480	SSCTIS600	SSCTIS480N	SSCTIS600N
				
	SSCTIL480	SSCTIL600	SSCTIL480N	SSCTIL600N

Ø 4.8
Ø 6.0

Fixture Lab Analog

- Achieves a fixture of the oral cavity on a working model
- Achieves small groove for G/H identification

-  Regular
-  Wide

D	
	
	SSFA480
	SSFA600

Ø 4.8
Ø 6.0

Hanaro Abutment

- Has three functions: fixture mount, transfer impression coping, abutment
- Must use specialized screw when using as an abutment
- Shoulder contact with fixture platform region
- Gold coloring for aesthetics
- 1.2 hex driver
- Recommended tightening torque : 30 Ncm
- Packing unit : abutment + Ti screw + mount screw

Order made
Abutment + Ti screw + mount screw order code
: product code + TH (ex : SSHM480CTH)

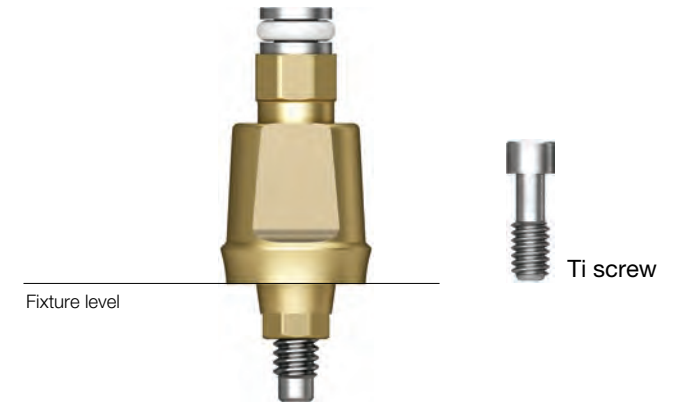

D Ø 4.8

-  Regular
- Ti screw : SSHAS



SSHM480C

D Ø 6.0

-  Wide
- Ti screw : SSHAS



SSHM600C

Octa

Abutment Level Impression

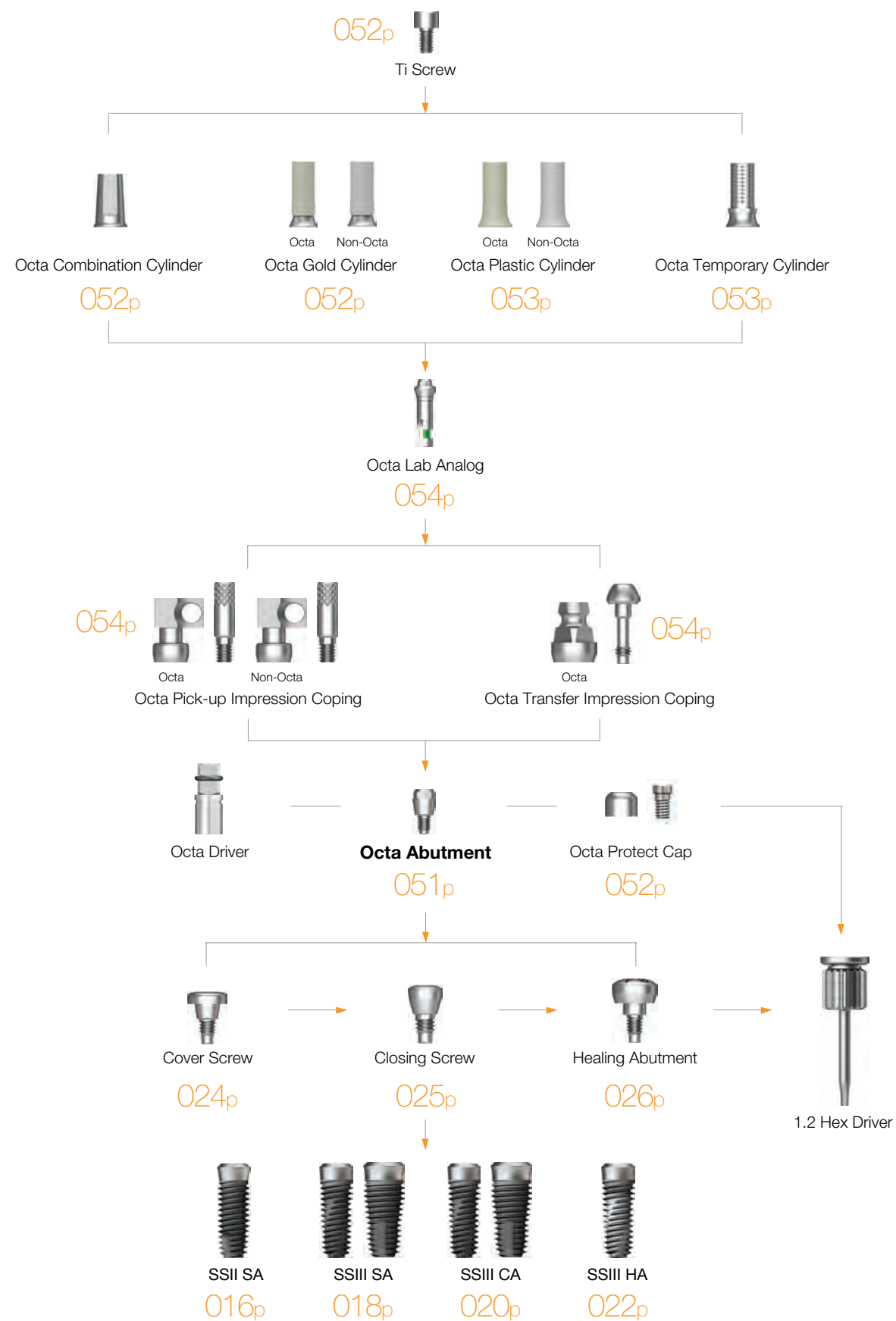

Octa Abutment

- Used in producing a screw-maintained prosthesis in bridge cases where path is not aligned
- Octa abutment driver (244p)
- Recommended tightening torque : 30Ncm



D Ø4.8



SSOA480

D Ø6.0



SSOA600

051

SS SYSTEM

050

SS SYSTEM

Octa Abutment Components

Octa Protect Cap

- Used when protecting an octa abutment in the oral cavity and minimizing foreign body sensation in the patient
- 1.2 hex driver
- Recommended tightening torque : 20Ncm
- Packing unit : protect cap + Ti screw

Protect cap + Ti screw order code
: product code + **TH** (ex : SSHC480**TH**)

R Regular

W Wide



Octa Gold Cylinder

- Prosthetic must be produced by casting dental-grade gold alloy
- Cylinder region fusion range : 1400°C~1450°C (casting with non-precious metal alloys is incompatible)
- 1.2 hex driver
- Recommended tightening torque : 20Ncm
- Packing unit : cylinder + Ti screw

Cylinder + Ti screw order code
: product code + **TH** (ex : SSGCO480**TH**)

R Regular

W Wide

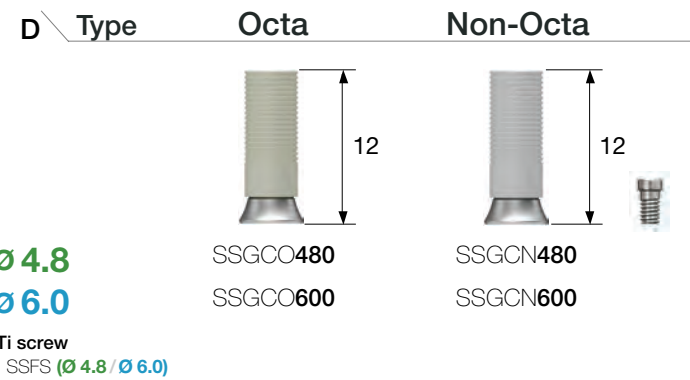

Octa Combination Cylinder

- Used in making a combination-retained prosthetic
- Inherent connection structure with two octa/non-octa advantages (max 60° path compensation)
- 1.2 hex driver
- Recommended tightening torque : 20Ncm
- Packing unit : cylinder + Ti screw

Cylinder + Ti screw order code
: product code + **TH** (ex : SSOCC480**TH**)

R Regular

W Wide

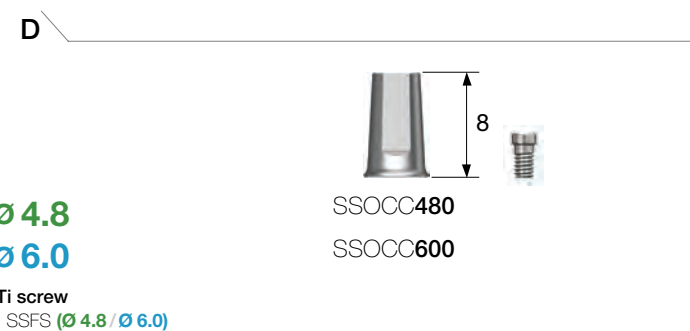

Octa Temporary Cylinder

- Used in producing temporary prosthetics (Material: Ti Gr-3)
- Structure enabling easy customization and minimizing indication restrictions
- Inherent connection structure with two octa/non-octa advantages (max 60° path compensation)
- 1.2 hex driver
- Recommended tightening torque : 20Ncm
- Packing unit : cylinder + Ti screw

Cylinder + Ti screw order code
: product code + **TH** (ex : SSTCO480**TH**)

R Regular

W Wide

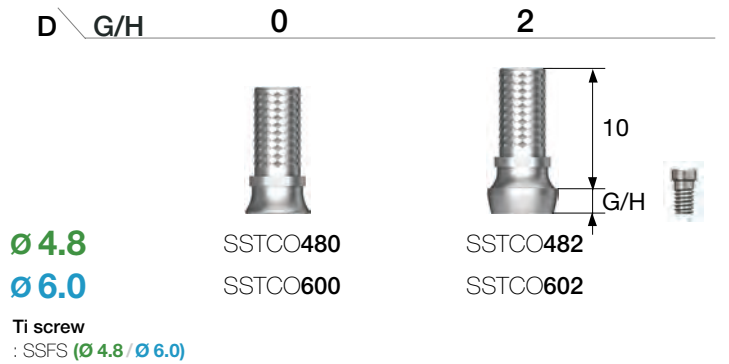

Octa Plastic Cylinder

- Prosthetic production by casting with dental-grade alloy (gold, non-precious metals) after customization
- Lower precision in connection area compared to gold cylinder
- 1.2 hex driver
- Recommended tightening torque : 20Ncm
- Packing unit : cylinder + Ti screw

Cylinder + Ti screw order code
: product code + **TH** (ex : SSPSO480**TH**)

R Regular

W Wide

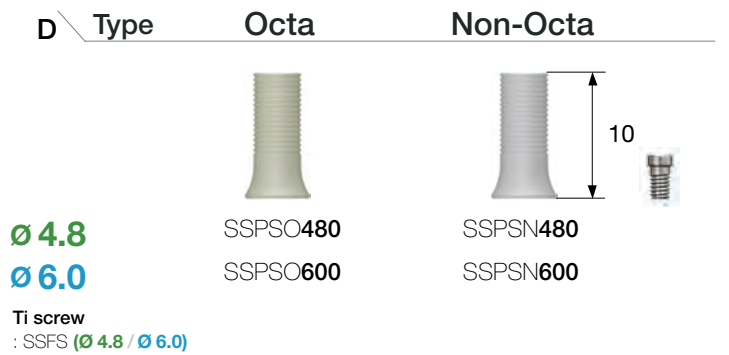

Octa Abutment Components

Octa Pick-up Impression Coping

- Takes impression using open tray
- Superior impression stability with holinone structure
- 1.2 hex driver
- * Label is basic packaging specification
- Packing unit : impression coping body + guide pin

R Regular
W Wide

D \ L	Octa	Non-Octa	Guide Pin	
			10	15
				
	SSICO480 SSICO600	SSICN480N SSICN600N	SSGS100	SSGS150*
	Ø 4.8 Ø 6.0			

OSSTEM[®]
IMPLANT

054

SS SYSTEM

Octa Transfer Impression Coping

- Takes impression using closed tray
- Packing unit : impression coping body + guide pin

R Regular
W Wide

D	
	
	SSOTI480 SSOTI600
	Ø 4.8 Ø 6.0

Octa Lab Analog

- Achieves octa abutment of the oral cavity on a working model
- Achieves small groove for G/H identification

R Regular
W Wide

D	
	
	SSLA480 SSLA600
	Ø 4.8 Ø 6.0

055

SS SYSTEM

O-ring Abutment

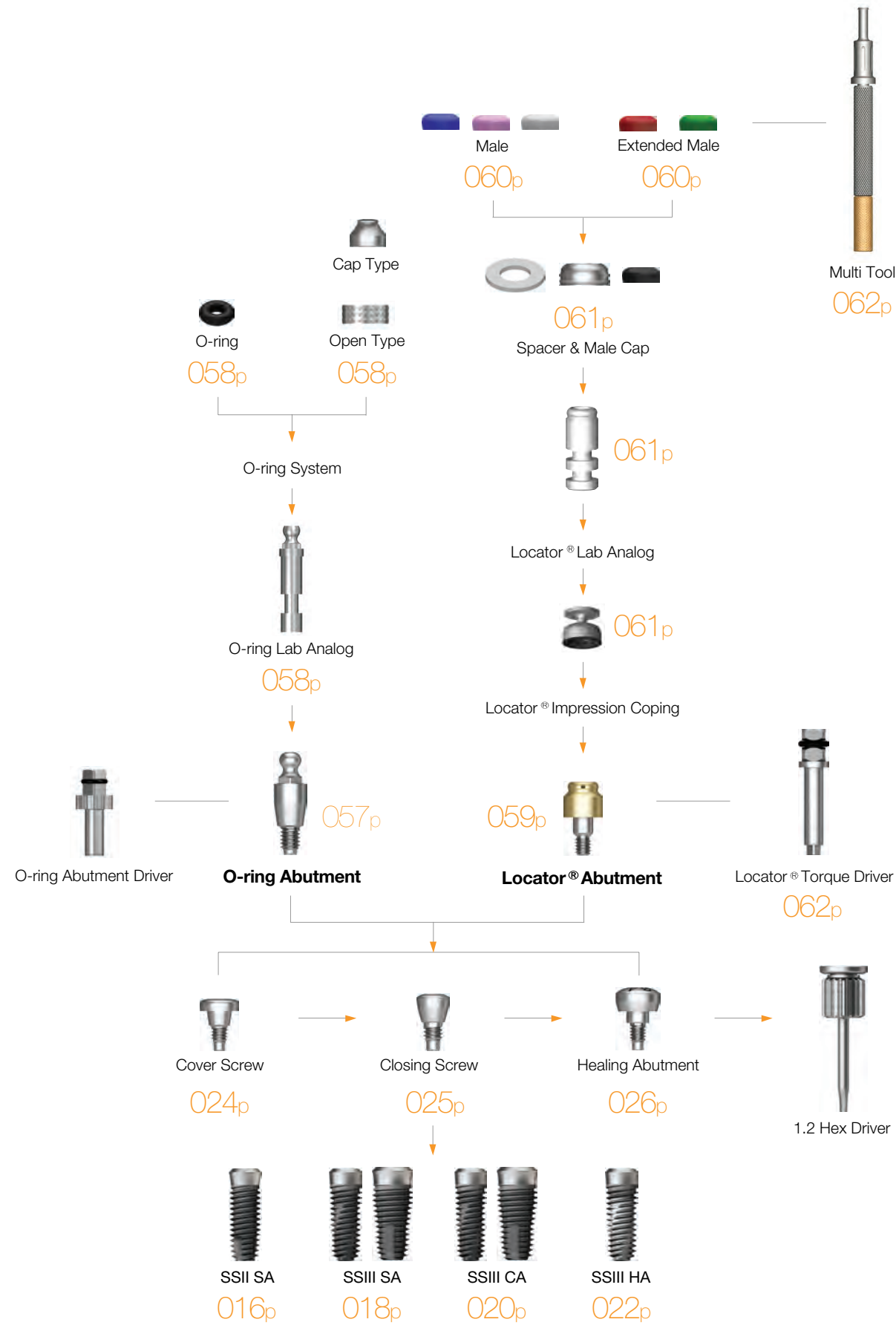

- Used in creating stud type overdenture prosthetics
- Compensates the path up to 20°
- O-ring abutment driver를 사용 (AORD)
- Recommended tightening torque : 30Ncm

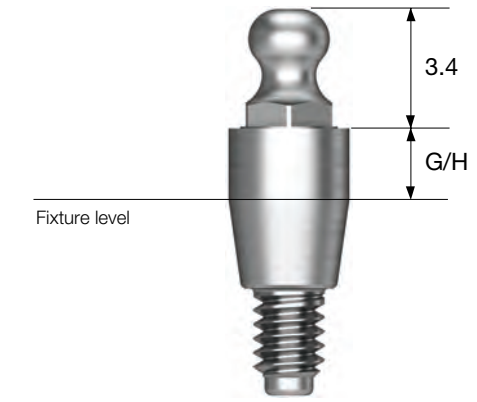

D Ø4.8
R



056

SS SYSTEM

057

SS SYSTEM

O-ring Abutment Components

O-ring Retainer Cap Set

- Used in creating stud type overdenture prosthetics
- Packing unit : retainer cap + o-ring



RCS01

O-ring Retainer Set

- Advantageous when occlusal clearance is low compared to retainer cap
- Packing unit : retainer + o-ring



RS01

O-ring Set

- Packing unit : 5ea



OAON01S

O-ring Lab Analog

- Achieves O-ring abutment of the oral cavity on a working model



OAL

Locator® Abutment

- Achieves low vertical dimension, stability, and various attachments with retention
- Possible path compensation up to 40° (two implant standard)
- Tightening by using a locator torque driver
- Recommended tightening torque : 30Ncm

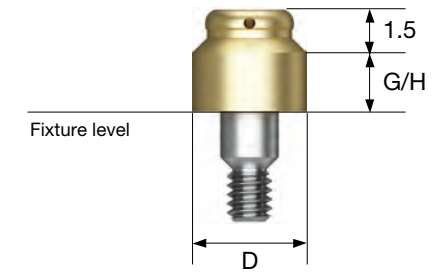

D Ø4.8

R

G/H	0.7	2.0	3.0	4.0
	HSLCA4810R	HSLCA4820R	HSLCA4830R	HSLCA4840R

Locator® Abutment Components

Locator® Male Processing Kit

- Component
 - Block out spacer / denture cap connected black processing male
 - Replacement male blue/pink/clear
- Used after selecting retention males that are appropriate for the case
- Exchanged with male using a locator core tool
- Packing unit : 2set



Locator® Black Processing Male

- Used in lab. process
- Packing unit : 4ea



Locator® Replacement Male

- Retention: Approximately 6N
- 0°~20° paths (two implant standard)
- Packing unit : blue replacement male 4ea



- Retention: Approximately 12N
- 0°~20° paths (two implant standard)
- Packing unit : pink replacement male 4ea



- Retention: Approximately 22N
- 0°~20° paths (two implant standard)
- Packing unit : clear replacement male 4ea



Locator® Block Out Spacers

- Gap sealing component between denture cap and abutment
- Packing unit : 20ea



Locator® Impression Coping

- Used in taking impressions after attaching locator abutment
- Packing unit : 4ea



Locator® Extended Replacement Male

- Retention: Approximately 6N
- 20°~40° paths (two implant standard)
- Packing unit : red extended replacement male 4ea



- Retention: Approximately 12N
- 20°~40° paths (two implant standard)
- Packing unit : green extended replacement male 4ea



Locator® Lab Analog

- Achieves locator abutment on the model
- Packing unit : 4ea



Locator® Abutment Components

Locator® Core Tool

- Used in attaching and changing replacement males



Locator® Torque Driver

- Used in locator abutment tightening



OSSTEM[®]
IMPLANT

Osstem Implant Key References

Clinic

No.	Title	Reference / Author
1	Retrospective clinical study of new tapered design implants in maxillary posterior areas	Oral Biology Research. 2013; 37(2):105-111 / Young-Kyun Kim et al.
2	A randomized controlled clinical trial of two types of tapered implants on immediate loading in the posterior maxilla and mandible	Int J Oral Maxillofac Implants. 2013 Nov-Dec;28(6):1602-11 (IF 1.908) / Young-Kyun Kim et al.
3	Bony window repositioning without using a barrier membrane in the lateral approach for maxillary sinus bone grafts: clinical and radiologic results at 6 months.	Int J Oral Maxillofac Implants. 2012 27:211-217 / Chang-Joo Park et al.
4	A relaxed implant bed: implants placed after two weeks of osteotomy with immediate loading: a one year clinical trial.	J Oral Implantol. 2012 Apr;38(2):155-64 / Bansal J et al.
5	A multicenter prospective study in type IV bone of a single type of implant	Implant Dent. 2012 Aug;21(4):330-34 / Su-Gwan Kim et al.
6	Comparison of clinical outcomes of sinus bone graft with simultaneous implant placement: 4-month and 6-month final prosthetic loading	Oral Surg Oral Med Oral Pathol Oral Radiol Endod. 2011 Feb;111(2):164-9 / Young-Kyun Kim et al.
7	Prospective study of tapered resorbable blasting media surface implant stability in the maxillary posterior area	Oral Surg Oral Med Oral Pathol Oral Radiol Endod. 2012 Feb 28. [Epub ahead of print] / Young-Kyun Kim et al.
8	A 1-year prospective clinical study of soft tissue conditions and marginal bone changes around dental implants after flapless implant surgery	Oral Surg Oral Med Oral Pathol Oral Radiol Endod. 2011 Jan;111(1):41-6 / Byung-Ho Choi et al.
9	Evaluation of peri-implant tissue in nonsubmerged dental implants: a multicenter retrospective study	Clin Implant Dent Relat Res. 2011 Dec;13(4):324-9 / Young-Kyun Kim et al.
10	A relaxed implant bed: implants placed after two weeks of osteotomy with immediate loading: a one year clinical trial	J Oral Implantol. 2012 Apr;38(2):155-64 / Bansal J et al.
11	A comparison of implant stability quotients measured using magnetic resonance frequency analysis from two directions: prospective clinical study during the initial healing period	Clin. Oral Impl. Res. 2010;21(6):591-7 / Jong-Ho Lee et al.
12	A short-term clinical study of marginal bone level change around microthreaded and platform-switched implants	J Periodontal Implant Sci. 2011;41:211-217 / Kyoo-Sung Cho et al.
13	A randomized clinical one-year trial comparing two types of nonsubmerged dental implant	Clin. Oral Impl. Res. 2010;21(2):228-36 / Jong-Ho Lee et al.
14	Short-term, multi-center prospective clinical study of short implants measuring less than 7mm	J Kor Dent Sci. 2010;3(1):11-6 / Young-Kyun Kim et al.
15	Evaluation of peri-implant tissue in nonsubmerged dental implants: a multicenter retrospective study	Oral Surg Oral Med Oral Pathol Oral Radiol Endod. 2009;108(2):189-95 / Young-Kyun Kim et al.

16	Evaluation of sinus bone resorption and marginal bone loss after sinus bone grafting and implant placement	Oral Surg Oral Med Oral Pathol Oral Radiol Endod. 2009;107:e21-8 / Young-Kyun Kim et al.
17	Evaluation of peri-implant tissue response according to the presence of keratinized mucosa	Oral Surg Oral Med Oral Pathol Oral Radiol Endod. 2009;107:e24-8 / Young-Kyun Kim et al.
18	Study on radiographic evaluation of marginal bone loss around osseointegrated implant after functional loading	J Kor Oral Maxillofac Surg. 2009;35:240-7 / Young - Deok, Chee
19	Four-year survival rate of RBM surface internal connection non-submerged implants and the change of the peri-implant crestal bone	J Korean Assoc Maxillofac Plast Reconstr Surg. 2009;31(3):237-42 / Sok-Min Ko et al.

Biology

No.	Title	Reference / Author
1	Experiment study of bone response to hydroxyapatite coating implants: bone-implant contact and removal torque test	Oral Surg Oral Med Oral Pathol Oral Radiol. 2012 Jun 29. [Epub ahead of print] / Young-Kyun Kim et al.
2	Experimental study about the bony healing of hydroxyapatite coating implants	J Kor Oral Maxillofac Surg. 2011;27(4):295-300 / Young-Kyun Kim et al.
3	The use of autologous venous blood for maxillary sinus floor augmentation in conjunction with sinus membrane elevation: an experimental study	Clin. Oral Impl. Res. 2010;21:346-9 / Byung-Ho Choi et al.
4	Effects of soft tissue punch size on the healing of peri-implant tissue in flapless implant surgery	Oral Surg Oral Med Oral Pathol Oral Radiol Endod. 2010;109:525-30 / Byung-Ho Choi et al.
5	Morphogenesis of the peri-implant mucosa: a comparison between flap and flapless procedures in the canine mandible	Oral Surg Oral Med Oral Pathol Oral Radiol Endod. 2009;107:66-70 / Byung-Ho Choi et al.
6	A comparative study of two noninvasive techniques to evaluate implant stability: periotest and osstell mentor	Oral Surg Oral Med Oral Pathol Oral Radiol Endod. 2009;107:513-8 / Su-Gwan Kim et al.
7	Influence of abutment connections and plaque control on the initial healing of prematurely exposed implants: an experimental study in dogs	J Periodontol. 2008;79(6):1070-4 / Byung-Ho Choi et al.
8	Er:YAG laser irradiated implant surface observation with scanning electron microscopy	J Korean Assoc Maxillofac Plast Reconstr Surg. 2008;30(6):540-5 / Seung-Ki Min et al.
9	The effect of surface treatment of the cervical area of implant on bone regeneration in mini-pig	J Kor Oral Maxillofac Surg. 2008;34:285-92 / Hong-Ju Park et al.

10	Histologic and histomorphometric evaluation of early and immediately loaded implants in the dog mandible	J Biomed Mater Res A. 2008;86:1122-7 / Su-Gwan Kim et al.
11	Effects of different depths of gap on healing of surgically created coronal defects around implants in dogs: a pilot study	J Periodontol. 2008;79(2):355-61 / June-Sung Shim et al.
12	Comparative study of removal effect on artificial plaque from RBM treated implant	J Korean Assoc Maxillofac Plast Reconstr Surg. 2007;29(4):309-20 / Hee-Jyun Oh et al.

Biomechanics

No.	Title	Reference / Author
1	Evaluation of the correlation between insertion torque and primary stability of dental implants using a block bone test	J Periodontal Implant Sci. 2013;43:41-46 / Ki-Tae Koo et al.
2	Self-cutting blades and their influence on primary stability of tapered dental implants in a simulated low-density bone model: a laboratory study	Oral Surg Oral Med Oral Pathol Oral Radiol Endod. 2011;112:573-580 / Young-Jun Lim et al.
3	Variation in the total lengths of abutment/implant assemblies generated with a function of applied tightening torque in external and internal implant-abutment connection	Clin. Oral Impl. Res. 2011;22:834-9 / Ki-Seong Kim et al.
4	Effect of impression coping and implant angulation on the accuracy of implant impressions: an in vitro study	J Adv Prosthodont. 2010;2(4):128-33 / Seung-Geun Ahn et al.
5	Influence of implant diameter and length changes on initial stability	J Kor Acad Prosthodont. 2009;47:335-41 / Chang-Mo Jeong et al.
6	Mechanical strength of zirconia abutment in implant restoration	J KASFO. 2009;25(4):349-60 / Young-Chan Jeon et al.
7	Heat transfer to the implant-bone interface during preparation of zirconia/alumina complex abutment	Int J Oral Maxillofac Implants. 2009;24(4):679-83 / Yong-Geun Choi et al.
8	Fatigue fracture of different dental Implant system under cyclic loading	J Kor Acad Prosthodont. 2009;47(4):424-34 / In-Ho Cho et al.
9	Effect of tightening torque on abutment-fixture joint stability using 3-dimensional finite element analysis	J Kor Acad Prosthodont. 2009;47(2):125-35 / Chang-Mo Jeong et al.
10	The effect of various thread designs on the initial stability of taper implants	J Adv. Prosthodont. 2009;1:19-25 / Young-Jun Lim et al.
11	Influence of tungsten carbide/carbon coating of implant-abutment screw on screw loosening	J Kor Acad Prosthodont. 2008;46(2):137-47 / Chang-Mo Jeong et al.

Osstem Implant product information

Osstem Implant dental fixtures and products are manufactured using medical grade Titanium. Osstem Implant abutments, denture material and surgical tools are only compatible with Osstem fixtures. For more detailed information about each product, please refer to the user manuals, catalogs or please visit our corporate website (www.osstem.com). Please check all product labels for product codes, specifications, manufactured dates and expiration dates.

Sterility

Fixtures, cover screws and healing abutments are cleansed and gamma-sterilized. These products are disposable sterile medical appliances, and must be used in a sterile field. If the package is damaged or has expired, it must not be used. If the product package has been opened but not used, there is a risk of contamination and it is not recommended that the product be resterilized and therefore should be discarded.

Storage conditions

Store all products in a dry place at room temperature (30°C). Avoid direct sunlight.

General precautions

Dental implant surgery require proper and formal training and education.

Cautions before dental surgery

Before dental implant surgery, a thorough patient health history review, oral and radiographic examinations must be completed to determine bone quality and proper treatment planning.

Cautions during dental implant surgery

Osstem Implant System are for single or two stage dental implant procedures. In order to minimize damage to the patient's tissue, special attention to temperature, surgical lesions and eliminating all sources of contamination and infection are needed. Any deviation from the standard surgical protocol increases the risk of failure. When inserting the dental implant, sufficient cooling must be introduced (water or saline) and excessive torque (greater than 55Ncm) can result in dental implant fracture or possibly bone necrosis. Placing dental implants greater than 300 has a very high risk of implant fracture. Direct pressure to the fixture should be avoided right after surgery. Immediate or delayed loading of the fixture must be determined after proper examination of the patient's bone condition and initial stability after placement.

Mini implants or implants with a diameter less than 4.0mm are not recommended for the posterior region.

Ultra-wide dental implants are recommended for the posterior region but should not be used with angled abutments. If considering an Ultra-wide dental implant, proper radiographic evaluation must be made to determine the bone mass and potential anatomical restrictions. Short dental implants (diameter greater than 5mm and shorter than 7mm) are only used for the posterior region. The clinician must

thoroughly evaluate the patient's condition and recognized the following issues:

- 1) bone loss due to peri-implantitis, 2) changes to the dental implant condition,
- 3) proper osseointegration determined by a x-ray examination. If there is movement or if there is bone loss more than 50%, removing the dental implant should be a course of action. Wide diameter implants should be performed as a two stage surgery. Sufficient healing time must be given before splinting with other implants or when loading. Immediate loading is not recommended.

Take care when placing dental implants with HA coating. The coating is prone to cracking or fracturing under high torque, therefore hard bone should be avoided and be inserted under 35Ncm of force.

CA and SOSI treated dental implants are encased in a solution to prevent the chemically treated surface from reacting with air. After removing the CA or SOSI dental implant, place the implant within 15 minutes to avoid degradation of the surface.

Warning

Improper patient selection and treatment planning may result in dental implant failure or loss of bone. Osstem Implants must not be used for purpose other than prescribed and must not be alter in any shape or form. Implant movement, bone loss, and chronic infections can result in implant failure.

Indications

Osstem Implant Systems are designed to replace a patient's tooth or teeth. They can be placed in both the maxillary and submaxillary alveolar bones and after full osseointegration can be restored prosthetically. Osstem Implant Systems offer both temporary and final prosthesis and can be retained by cement, screw, overdenture or fixed bridge.

Side effects

There are possible side effects after implant surgery (lost of implant stability, damage to dentures). These issues can be due to the lack of bone or poor bone quality, an infection, patient's poor oral hygiene, non compliance with post op procedures, movement of the implant, degradation of surrounding tissue, or improper placement of the dental implant.

Contraindications

- Patients with the following contraindications are not eligible for dental implants:
- Patients with blood clotting issues or issues with wound healing.
 - Diabetic patients
 - Patients that smoke or drink excessively
 - Patient's with compromised immune systems due disease or chemo and radiation therapy.
 - Patients with an oral infection or inflammation (improper oral hygiene or teeth grinding)
 - Patients with an incurable malocclusion/arthritis and insufficient arch space.

Manufacturer : Osstem Implant Co., Ltd.
203, Geoje-daero, Yeonje-gu, Busan, Korea
TEL 82-51-850-2500 FAX 82-51-861-4693



0434



Sterilized using irradiation



Use by



Manufacture



DEUTSCHE OSSTEM GmbH.
Mergenthalerallee 25
65760 Eschborn, Germany
+49-(0)6196-777-550



Do not reuse



Date of manufacture



Keep away from sunlight

Storage condition

Dry place at room temperature



Catalogue number



Non-Sterile



Keep dry

Rx only

For USA only : Federal law restricts this device to sale by or on the order of a dentist



Batch code



Do not resterilize



Caution, Consult accompanying documents

OSSTEM[®]
IMPLANT